

ZIEXTENZO[®] Pegfilgrastim

PATIENT

ALERT CARD

How to use device

INSTRUCTIONS FOR USE OF ZIEXTENZO PRE-FILLED SYRINGE

To help avoid possible infections and to ensure that you use the medicine correctly, it is important that you follow these instructions.

Read ALL the way through these instructions before injecting. It is important not to try to inject yourself until you have been trained by your doctor, nurse or pharmacist. The carton contains the pre-filled syringe individually sealed in a plastic blister.

YOUR ZIEXTENZO PRE-FILLED SYRINGE WITH NEEDLE GUARD

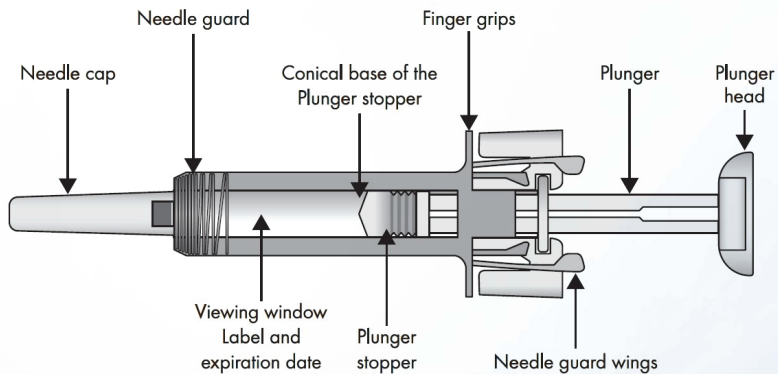

After the medicine has been injected, the needle guard will be activated to cover the needle. The needle guard is intended to protect healthcare professionals, caregivers and patients from accidental needle sticks after the injection.

WHAT YOU ADDITIONALLY NEED FOR YOUR INJECTION:

- Alcohol swab.
- Cotton ball or gauze.
- Sharps disposal container.v



IMPORTANT SAFETY INFORMATION

CAUTION: KEEP THE PRE-FILLED SYRINGE OUT OF THE SIGHT AND REACH OF CHILDREN.

1. Do not open the carton until you are ready to use the pre-filled syringe.
2. Do not use the pre-filled syringe if the seal of the blister is broken, as it may not be safe for you to use.
3. Never leave the pre-filled syringe unattended where others might tamper with it.
4. Do not shake the pre-filled syringe.
5. Be careful not to touch the needle guard wings before use. By touching them, the needle guard may be activated too early.
6. Do not remove the needle cap until just before you give the injection.
7. The pre-filled syringe cannot be re-used. Dispose of the used pre-filled syringe immediately after use in a sharps container.

STORAGE OF THE ZIEXTENZO PRE-FILLED SYRINGE

1. Store the blistered pre-filled syringe in its carton to protect it from light.
2. Store in the refrigerator between 2 °C and 8 °C. Do not freeze.
3. Prior to use, remove the pre-filled syringe from the refrigerator and allow Ziextenzo to reach room temperature (up to a maximum of 35 °C) for approximately 15-30 minutes.
4. **Do not use** the pre-filled syringe after the expiry date which is stated on the carton or syringe label. If it has expired, return the entire pack to the pharmacy.

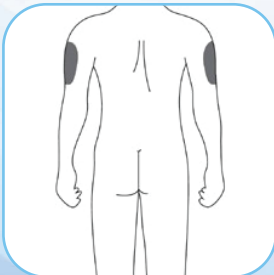
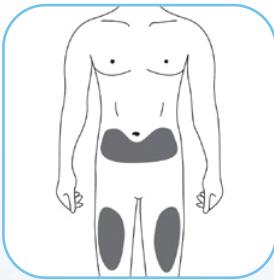

THE INJECTION SITE

THE INJECTION SITE IS THE PLACE ON THE BODY WHERE YOU ARE GOING TO USE THE PRE-FILLED SYRINGE.

- The recommended site is the front of your thighs. You may also use the lower abdomen, but not the area 5 centimetres around the navel (belly button).
- Choose a different site each time you give yourself an injection.
- Do not inject into areas where the skin is tender, bruised, red, scaly or hard. Avoid areas with scars or stretch marks.

If a caregiver is giving you the injection, the outer upper arms may also be used.

PREPARING THE ZIEXTENZO PRE-FILLED SYRINGE READY FOR USE

1. Take the carton containing the blistered pre-filled syringe out of the refrigerator and leave it unopened for approximately 15-30 minutes so that it reaches room temperature.
2. When you are ready to use the pre-filled syringe, open the blister and wash your hands thoroughly with soap and water.
3. Clean the injection site with an alcohol swab.
4. Remove the pre-filled syringe from the blister. Check to ensure the plastic transparent needle guard is situated over the barrel of the glass syringe. If the transparent needle guard is covering the needle cap (as shown below) the syringe has been activated, **DO NOT** use this syringe and take a new syringe. The figure below shows a ready to use syringe.
5. Inspect the pre-filled syringe. The liquid should be clear. Its colour may vary from colourless to slightly yellowish. You may see a small air bubble in the liquid. This is normal. Do not use the pre-filled syringe if any other particulates and/or discolouration are observed.
6. Do not use if the syringe is broken or activated. Return the Ziextenzo pre-filled syringe and the package to your pharmacy.

DEVICE ACTIVATED - DO NOT USE

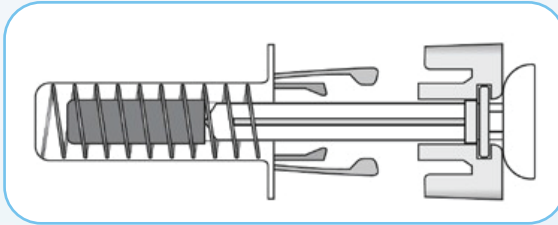

In this configuration the needle guard is **ACTIVATED - DO NOT USE** the pre-filled syringe

DEVICE READY TO BE USED

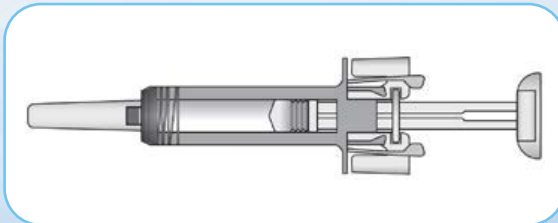

In this configuration the needle guard is **NOT ACTIVATED** and the pre-filled syringe is ready for use

HOW TO USE THE ZIEXTENZO PRE-FILLED SYRINGE

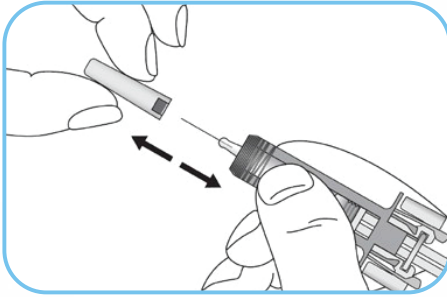

1

Carefully pull the needle cap straight off. You may see a drop of liquid at the end of the needle. This is normal.

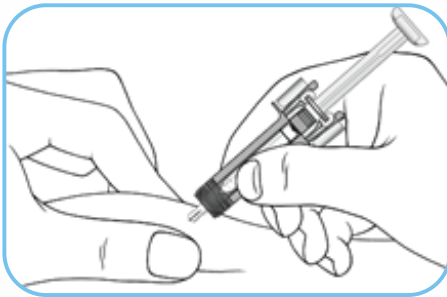

2

Gently pinch the skin at the injection site and insert the needle as shown. Push the needle all the way in to ensure that the medicine can be fully administered.

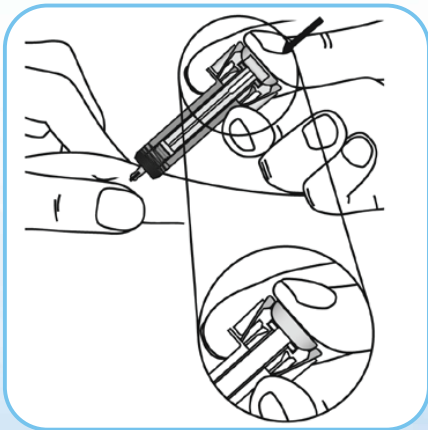

3

Holding the pre-filled syringe as shown, slowly depress the plunger as far as it will go so that the plunger head is completely between the needle guard wings. Keep the plunger pressed fully down while you hold the syringe in place for 5 seconds.

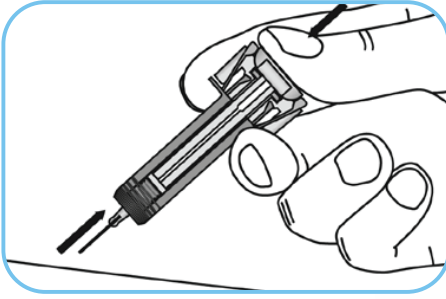

4

Keep the plunger fully depressed while you carefully pull the needle straight out from the injection site and let it go off your skin.

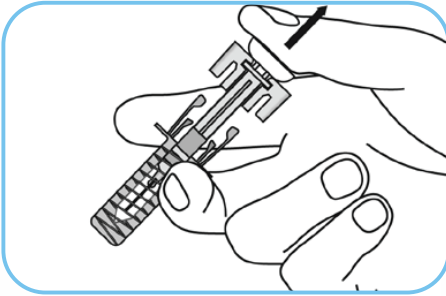

5

Slowly release the plunger and allow the syringe needle guard to automatically cover the exposed needle. There may be a small amount of blood at the injection site. You can press a cotton ball or gauze onto the injection site and hold it for 10 seconds. Do not rub the injection site. You may cover the injection site with a small adhesive bandage, if needed.

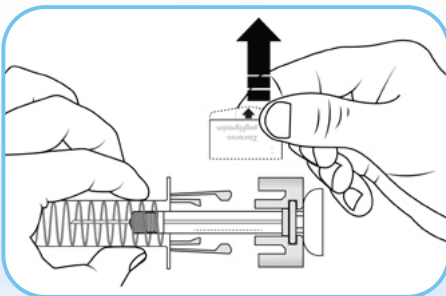

6

Healthcare providers only
The trade name of the administered product should be clearly recorded in the patient file. Remove and save the pre-filled syringe label. Turn the plunger to move the label into a position where you can remove the syringe label.

DISPOSAL INSTRUCTIONS

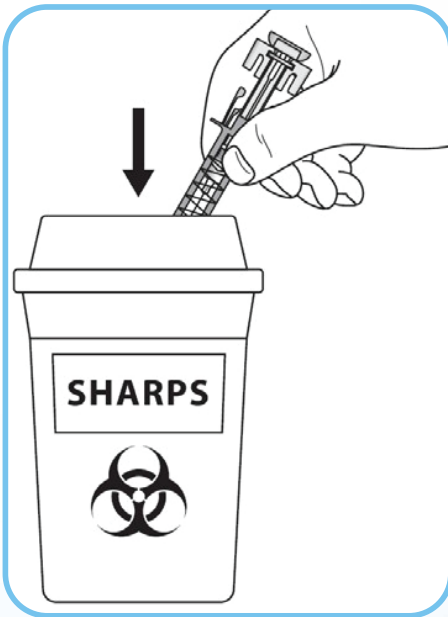

Dispose of the used syringe in a sharps container (closable, puncture resistant container).

Do not throw away any medicines via wastewater or household waste. Ask your doctor or pharmacist how to throw away medicines you no longer use. These measures will help protect the environment. Any unused product or waste material should be disposed of in accordance with local requirements.

You can report any problem or adverse events or request additional copies of the materials through:

Patient Safety Department Novartis Pharma AG - Saudi Arabia -

Toll Free Number: 8001240078

Phone: +966112658100

Fax: +966112658107

Email: adverse.events@novartis.com

Website: <http://report.novartis.com/>

Saudi Food and Drug Authority National Pharmacovigilance Center

Unified Contact Center: 19999

Toll Free Number: 80024900000

Fax: +966112057662

Email: npc.drug@sfd.gov.sa

Website: <https://ade.sfd.gov.sa>

This document has been approved by Saudi Food and Drug Authority (SFDA).